

Built-in Hob

User manual



HIC 64502 T

EN

185.9102.02/R.AA/17.11.2015

Please read this user manual first!

Dear Customer,

Thank you for purchasing this Beko product. We hope that you get the best results from your product which has been manufactured with high quality and state-of-the-art technology. Therefore, please read this entire user manual and all other accompanying documents carefully before using the product and keep it as a reference for future use. If you handover the product to someone else, give the user manual as well. Follow all warnings and information in the user manual.

Remember that this user manual is also applicable for several other models. Differences between models will be identified in the manual.

Explanation of symbols

Throughout this user manual the following symbols are used:

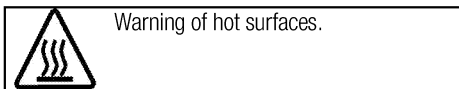
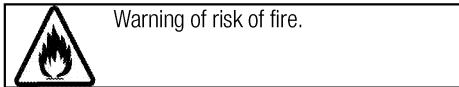
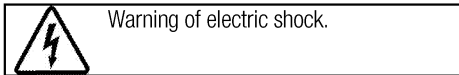
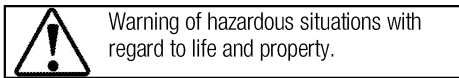
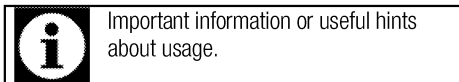

Arçelik A.Ş.
Karaağaç caddesi No:2-6
34445 Sütlüce/İstanbul/TURKEY
Made in TURKEY



This product was manufactured using the latest technology in environmentally friendly conditions.

**1 Important instructions and warnings
for safety and environment 4**

General safety 4
 Electrical safety 4
 Product safety 5
 Intended use 6
 Safety for children 6
 Disposing of the old product 6
 Package information 6
 Future Transportation 6

2 General information 7

Overview 7
 Technical specifications 7

3 Installation 8

Before installation 8
 Installation and connection 8

4 Preparation 11

Tips for saving energy 11
 Initial use 11
 First cleaning of the appliance 11
 Initial heating 11

5 How to use the hob 12

General information about cooking 12
 Using the hobs 12
 Control panel 13

6 Maintenance and care 20

General information 20
 Cleaning the hob 20

7 Troubleshooting 21

1 Important instructions and warnings for safety and environment

This section contains safety instructions that will help protect from risk of personal injury or property damage. Failure to follow these instructions shall void any warranty.

General safety

- This appliance can be used by children aged from 8 years and above and persons with reduced physical, sensory or mental capabilities or lack of experience and knowledge if they have been given supervision or instruction concerning use of the appliance in a safe way and understand the hazards involved.
Children shall not play with the appliance. Cleaning and user maintenance shall not be made by children without supervision.
- Installation and repair procedures must always be performed by Authorized Service Agents. The manufacturer shall not be held responsible for damages arising from procedures carried out by unauthorized persons which may also void the warranty. Before installation, read the instructions carefully.
- Do not operate the product if it is defective or has any visible damage.

- Ensure that the product function knobs are switched off after every use.

Electrical safety

- If the product has a failure, it should not be operated unless it is repaired by an Authorized Service Agent. There is the risk of electric shock!
- Only connect the product to a grounded outlet/line with the voltage and protection as specified in the “Technical specifications”. Have the grounding installation made by a qualified electrician while using the product with or without a transformer. Our company shall not be liable for any problems arising due to the product not being earthed in accordance with the local regulations.
- Never wash the product by spreading or pouring water onto it! There is the risk of electric shock!
- The product must be disconnected during installation, maintenance, cleaning and repairing procedures.
- If the power connection cable for the product is damaged, it must be replaced by the manufacturer, its service agent or similarly

qualified persons in order to avoid a hazard.

- The appliance must be installed so that it can be completely disconnected from the mains supply. The separation must be provided by a switch built into the fixed electrical installation, according to construction regulations.
- Any work on electrical equipment and systems should only be carried out by authorized and qualified persons.
- In case of any damage, switch off the product and disconnect it from the mains. To do this, turn off the fuse at home.
- Make sure that fuse rating is compatible with the product.

Product safety

- The appliance and its accessible parts become hot during use. Care should be taken to avoid touching heating elements. Children less than 8 years of age shall be kept away unless continuously supervised.
- Never use the product when your judgment or coordination is impaired by the use of alcohol and/or drugs.
- Be careful when using alcoholic drinks in your dishes. Alcohol evaporates at high temperatures and may cause fire since it can

ignite when it comes into contact with hot surfaces.

- Do not place any flammable materials close to the product as the sides may become hot during use.
- Keep all ventilation slots clear of obstructions.
- Do not use steam cleaners to clean the appliance as this may cause an electric shock.
- Unattended cooking on a hob with fat or oil can be dangerous and may result in fire. NEVER try to extinguish a fire with water, but switch off the appliance and then cover flame e.g. with a lid or a fire blanket.
- Danger of fire: Do not store items on the cooking surfaces.
- If the surface is cracked, switch off the appliance to avoid the possibility of electric shock.
- The appliance is not intended to be operated by means of an external timer or separate remote-control system.
- Vapour pressure that build up due to the moisture on the hob surface or at the bottom of the pot can cause the pot to move. Therefore, make sure that the oven surface and bottom of the pots are always dry.
- Use only hob guards designed by the manufacturer of the cooking appliance or indicated by the

manufacturer of the appliance in the instructions for use as suitable or hob guards incorporated in the appliance. The use of inappropriate guards can cause accidents.

Prevention against possible fire risk!

- Ensure all electrical connections are secure and tight to prevent risk of arcing.
- Do not use damaged cables or extension cables.
- Ensure liquid or moisture is not accessible to the electrical connection point.

Intended use

- This product is designed for domestic use. Commercial use will void the guarantee.
- This appliance is for cooking purposes only. It must not be used for other purposes, for example room heating.
- The manufacturer shall not be liable for any damage caused by improper use or handling errors.

Safety for children

- Accessible parts may become hot during use. Young children should be kept away.
- The packaging materials will be dangerous for children. Keep the packaging materials away from children. Please dispose of all parts of the packaging according to environmental standards.
- Electrical products are dangerous to children. Keep children away

from the product when it is operating and do not allow them to play with the product.

- Do not place any items above the appliance that children may reach for.

Disposing of the old product Compliance with the WEEE Directive and Disposing of the Waste Product:



This product complies with EU WEEE Directive (2012/19/EU). This product bears a classification symbol for waste electrical and electronic equipment (WEEE).

This product has been manufactured with high quality parts and materials which can be reused and are suitable for recycling. Do not dispose of the waste product with normal domestic and other wastes at the end of its service life. Take it to the collection center for the recycling of electrical and electronic equipment. Please consult your local authorities to learn about these collection centers.

Compliance with RoHS Directive:

The product you have purchased complies with EU RoHS Directive (2011/65/EU). It does not contain harmful and prohibited materials specified in the Directive.

Package information

- Packaging materials of the product are manufactured from recyclable materials in accordance with our National Environment Regulations. Do not dispose of the packaging materials together with the domestic or other wastes. Take them to the packaging material collection points designated by the local authorities.

Future Transportation

- Keep the product's original carton and transport the product in it. Follow the instructions on the carton. If you do not have the original carton, pack the product in bubble wrap or thick cardboard and tape it securely.



Check the general appearance of your product for any damages that might have occurred during transportation.

2 General information

Overview

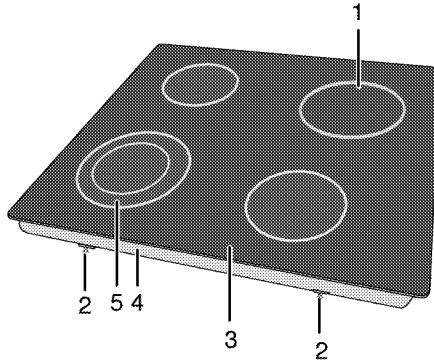

- | | | | |
|---|------------------------------|---|----------------------------|
| 1 | Single-circuit cooking plate | 4 | Base cover |
| 2 | Assembly clamp | 5 | Dual-circuit cooking plate |
| 3 | Burner plate | | |

Technical specifications

Voltage / frequency	220-240 V ~ 50 Hz
Total power consumption	6700 W
Fuse	min. 25 A
Cable type / section	H05RR-F 5 x 1,5 mm ²
External dimensions (height / width / depth)	55 mm/580 mm/510 mm
Installation dimensions (width / depth)	560 mm/490 mm
Burners	
Rear left	Single-circuit cooking plate
Dimension	140 mm
Power	1200 W
Front left	Dual-circuit cooking plate
Dimension	120/210 mm
Power	750/2200 W
Front right	Single-circuit cooking plate
Dimension	160 mm
Power	1500 W
Rear right	Single-circuit cooking plate
Dimension	180 mm
Power	1800 W



Technical specifications may be changed without prior notice to improve the quality of the product.



Figures in this manual are schematic and may not exactly match your product.



Values stated on the product labels or in the documentation accompanying it are obtained in laboratory conditions in accordance with relevant standards. Depending on operational and environmental conditions of the product, these values may vary.

3 Installation

Product must be installed by a qualified person in accordance with the regulations in force. The manufacturer shall not be held responsible for damages arising from procedures carried out by unauthorized persons which may also void the warranty.



Preparation of location and electrical installation for the product is under customer's responsibility.



DANGER:

The product must be installed in accordance with all local electrical regulations.



DANGER:

Prior to installation, visually check if the product has any defects on it. If so, do not have it installed.

Damaged products cause risks for your safety.

Before installation

The hob is designed for installation into commercially available work tops. A safety distance must be left between the appliance and the kitchen walls and furniture. See figure (values in mm).

- It can also be used in a free standing position. Allow a minimum distance of 750 mm above the hob surface.
- (*) If a cooker hood is to be installed above the cooker, refer to cooker hood manufacturer' instructions regarding installation height (min 650 mm)
- Remove packaging materials and transport locks.
- Surfaces, synthetic laminates and adhesives used must be heat resistant (100 °C minimum).
- The worktop must be aligned and fixed horizontally.
- Cut aperture for the hob in worktop as per installation dimensions.

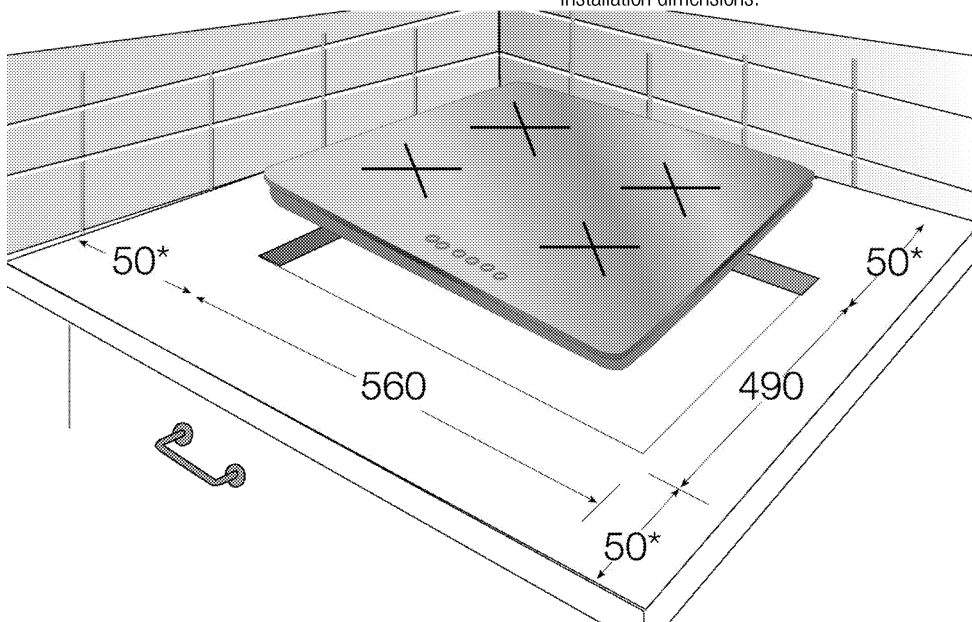

* min.

Installation and connection

- The product must be installed in accordance with all local gas and electrical regulations.



Do not install the hob on places with sharp edges or corners.

There is the risk of breaking for glass ceramic surface!

Electrical connection

Connect the product to a grounded outlet/line protected by a fuse of suitable capacity as stated in the "Technical specifications" table. Have the grounding installation made by a qualified electrician while using the product with or without a transformer. Our company shall not be liable for any damages that will arise due to using the product without a grounding installation in accordance with the local regulations.



DANGER:

The product must be connected to the mains supply only by an authorised and qualified person. The product's warranty period starts only after correct installation. Manufacturer shall not be held responsible for damages arising from procedures carried out by unauthorised persons.



DANGER:

The power cable must not be clamped, bent or trapped or come into contact with hot parts of the product.
A damaged power cable must be replaced by a qualified electrician. Otherwise, there is risk of electric shock, short circuit or fire!

- Connection must comply with national regulations.
- The mains supply data must correspond to the data specified on the type label of the product. Type label is at the rear housing of the product.
- Power cable of your product must comply with the values in "Technical specifications" table.



DANGER:

Before starting any work on the electrical installation, disconnect the product from the mains supply.
There is the risk of electric shock!

Connecting the power cable

1. If it is not possible to disconnect all poles in the supply power, a disconnection unit with at least 3 mm contact clearance (fuses, line safety switches, contactors) must be connected and all the poles of this disconnection unit must be adjacent to (not above) the product in accordance with IEE directives. Failure to obey this instruction may cause operational problems and invalidate the product warranty.

Additional protection by a residual current circuit breaker is recommended.

If a cable is supplied with the product:

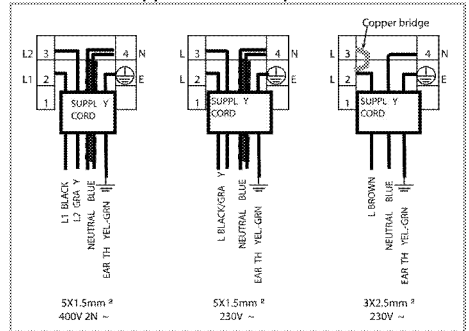

2. For single-phase connection, connect the wires as identified below:

- Brown/Black cable = L (Phase)
- Blue/Grey cable = N (Neutral)
- Green/yellow cable = (E) \equiv (Ground)

Installing the product

1. Turning the hob upside down, place it on a flat surface.
2. The sealing gasket provided in the package must be applied on the lower casing bend around the hob as shown in the figure, during installation of the hob.

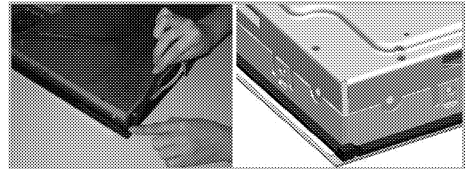

3. Place the hob on the counter and align it.
4. Using the installation clamps secure the hob by fitting through the holes on the lower casing.

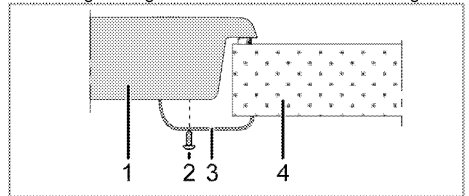

- 1 Hob
- 2 Screw
- 3 Installation clamp
- 4 Counter



When installing the hob onto a cabinet, a shelf must be installed in order to separate the cabinet from the hob as illustrated in the above figure. This is not required when installing onto a built-under oven.

For example, if it is possible to touch the bottom of the product since it is installed onto a drawer, this section must be covered with a wooden plate.

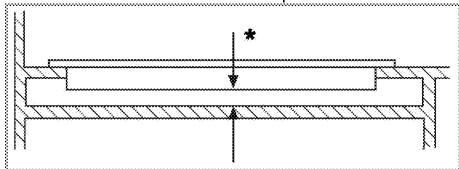

* min. 15 mm

Rear view (connection holes)

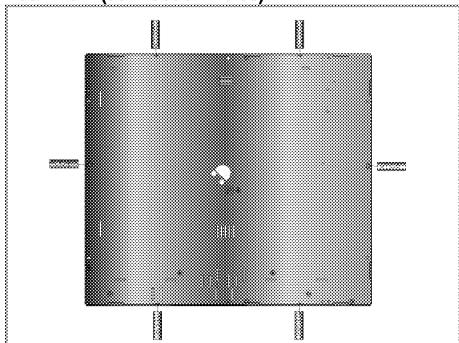

DANGER:

Making connections to different holes is not a good practice in terms of safety since it can damage the gas and electrical system.



DANGER:

There are gas and electric components on hobs. Therefore stove, only the connection hole shown in this manual should only be fixed to the unit as shown in the manual using the supplied fasteners and screws supplied. Otherwise, it is dangerous to the life and property safety.

Final check

1. Plug in the power cable and switch on the product's fuse.
2. Check the functions.

4 Preparation

Tips for saving energy

The following information will help you to use your appliance in an ecological way, and to save energy:

- Defrost frozen dishes before cooking them.
- Use pots/pans with cover for cooking. If there is no cover, energy consumption may increase 4 times.
- Select the burner which is suitable for the bottom size of the pot to be used. Always select the correct pot size for your dishes. Larger pots require more energy.
- Pay attention to use flat bottom pots when cooking with electric hobs.
Pots with thick bottom will provide a better heat conduction. You can obtain energy savings up to 1/3.
- Vessels and pots must be compatible with the cooking zones. Bottom of the vessels or pots must not be smaller than the hotplate.
- Keep the cooking zones and bottom of the pots clean. Dirt will decrease the heat conduction between the cooking zone and bottom of the pot.
- For long cookings, turn off the cooking zone 5 or 10 minutes before the end of cooking time. You can obtain energy savings up to 20% by using the residual heat.

Initial use

First cleaning of the appliance



The surface might get damaged by some detergents or cleaning materials.

Do not use aggressive detergents, cleaning powders/creams or any sharp objects during cleaning.

Do not use harsh abrasive cleaners or sharp metal scrapers to clean the oven door glass since they can scratch the surface, which may result in shattering of the glass.

1. Remove all packaging materials.
2. Wipe the surfaces of the appliance with a damp cloth or sponge and dry with a cloth.

Initial heating



Smoke and smell may emit for a couple of hours during the initial operation. This is quite normal. Ensure that the room is well ventilated to remove the smoke and smell. Avoid directly inhaling the smoke and the smell that emits.

5 How to use the hob

General information about cooking



Never fill the pan with oil more than one third of it. Do not leave the hob unattended when heating oil. Overheated oils bring risk of fire. **Never attempt to extinguish a possible fire with water!** When oil catches fire, cover it with a fire blanket or damp cloth. Turn off the hob if it is safe to do so and call the fire department.

- Before frying foods, always dry them well and gently place into the hot oil. Ensure complete thawing of frozen foods before frying.
- Do not cover the vessel you use when heating oil.
- Place the pans and saucepans in a manner so that their handles are not over the hob to prevent heating of the handles. Do not place unbalanced and easily tilting vessels on the hob.
- Do not place empty vessels and saucepans on cooking zones that are switched on. They might get damaged.
- Operating a cooking zone without a vessel or saucepan on it will cause damage to the product. Turn off the cooking zones after the cooking is complete.
- As the surface of the product can be hot, do not put plastic and aluminum vessels on it. Clean any melted such materials on the surface immediately. Such vessels should not be used to keep foods either.
- Use flat bottomed saucepans or vessels only.
- Put appropriate amount of food in saucepans and pans. Thus, you will not have to make any unnecessary cleaning by preventing the dishes from overflowing. Do not put covers of saucepans or pans on cooking zones. Place the saucepans in a manner so that they are centered on the cooking zone. When you want to move the saucepan onto another cooking zone, lift and place it onto the cooking zone you want instead of sliding it.

Tips about glass ceramic hobs

- Glass ceramic surface is heatproof and is not affected by big temperature differences.

- Do not use the glass ceramic surface as a place of storage or as a cutting board.
- Use only the saucepans and pans with machined bottoms. Sharp edges create scratches on the surface.
- Do not use aluminum vessels and saucepans. Aluminum damages the glass ceramic surface.

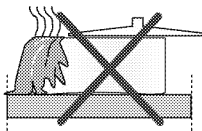

Spills may damage the glass ceramic surface and cause fire.

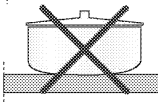

Do not use vessels with concave or convex bottoms.

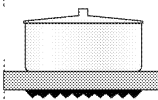

Use only the saucepans and pans with flat bottoms. They ensure easier heat transfer. If the diameter of the saucepan is too small, energy will be wasted.

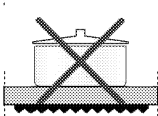

Using the hobs

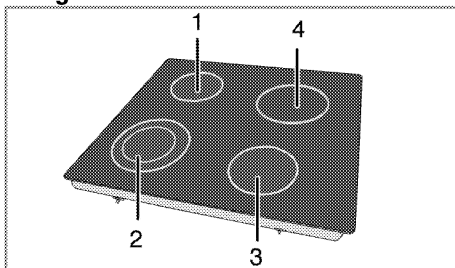

- 1 Single-circuit cooking plate 14-16 cm
- 2 Dual-circuit cooking plate 12-14/21-23 cm
- 3 Single-circuit cooking plate 16-18 cm
- 4 Single-circuit cooking plate 18-20 cm is list of advised diameter of pots to be used on related burners.



DANGER:

Do not allow any object to drop on the hob. Even small objects such as a saltshaker may damage the hob.

Do not use cracked hobs. Water may leak through these cracks and cause short circuit. In case of any kind of damage on the surface (eg., visible cracks), switch off the product immediately to minimize the risk of electric shock.



Quick heating glass-ceramic hobs emit a bright light when they are switched on. Do not stare at the bright light.



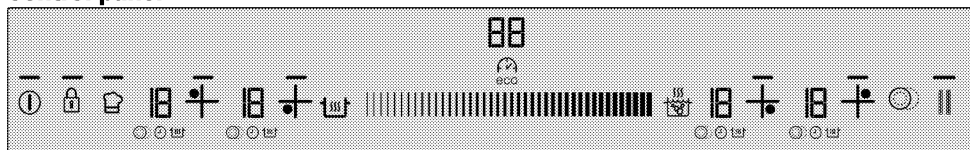









Control panel



Specifications



Adjustment area (for temperature level and time setting)

-  Light indicating that the relevant key is functioning
-  On / Off key
-  Keylock key
-  Multi-segmented Cooking Zone Selection key
-  Timer Activation / Deactivation key
-  Quick Heating key / Booster key
-  Keep Warm key
-  Stop key
-  Memory key
-  Front Left Cooking Zone Selection key
-  Rear Left Cooking Zone Selection key
-  Rear Right Cooking Zone Selection key
-  Front Right Cooking Zone Selection key



Graphics and figures are for informational purposes only. Actual displays and functions may vary according to the model of your hob.

Cooking zone display

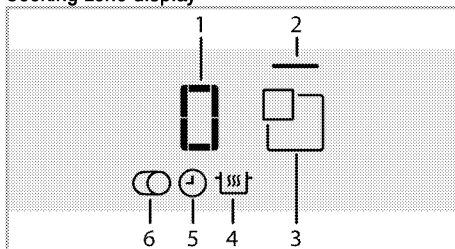

- 1 Temperature Indicator (temperature setting 0 ... 19)
 - 2 Cooking zone light
 - 3 Cooking Zone Selection key
 - 4 Keep Warm Function symbol (*)
 - 5 Timer symbol
 - 6 Multi-segmented Cooking Zone symbol (*)
- * Varies according to the model.



This device is controlled with a touch control panel. Each operation you make on your touch control panel will be confirmed by an audible signal.



Always keep the control panel clean and dry. Having damp and soiled surface may cause problems in the functions.

Turning on the hob

1. Touch "⏻" key on the control panel.

Light of the "⏻" key turns on. The hob is ready for use.



If no operation is performed within 20 seconds, the hob will automatically return to Standby mode.



When any key ("⏻" key) is pressed for a long time, the product automatically turns off for safety reasons.

Turning off the hob

1. Touch "⏻" key on the control panel.

The hob will turn off and return to Standby mode.



"H" or "h" and then "-" symbols that appear on the cooking zone display after the hob is turned off indicates that the cooking zone is still hot. Do not touch cooking zones.

Residual heat indicator

"H" and then "-" symbols that appear on the cooking zone display indicates that the hob is still hot and may be used to keep a small amount of food warm. This symbol will soon turn to "h" and "-" symbol meaning less hot.



When power is cut off, residual heat indicator will not light up and does not warn the user against hot cooking zones.

If power fails and restores before the cooking zones cool down, "-" appears on the relevant cooking zone display. This symbol will disappear if the relevant cooking zone is operated.

Turning on the cooking zones

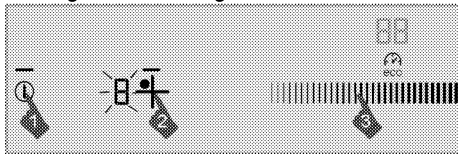

1. Touch "⏻" key to turn on the hob.
2. Touch the selection key of the cooking zone you want to turn on.

"0" appears on the cooking zone display and the light of the relevant cooking zone illuminates.



If no operation is performed within 20 seconds, the hob will automatically return to Standby mode.

Setting the temperature level

By touching the adjustment area or by sliding your finger across the area, adjust the temperature level between "0" and "19".

Turning off the cooking zones:

A cooking zone can be turned off in 3 different ways:

1. **By dropping the temperature level to "0"**
You can turn the cooking zone off by dropping the temperature level to "0".
2. **By using the turning off through the timer option for the desired cooking zone**
When the time is over, the timer will turn off the cooking zone assigned to it. "0" or "00" will appear on all displays. The "⏻" symbol on the hob display will disappear.
When the time is over, an audible alarm will sound. Touch any key on the control panel to silence the audible alarm.
3. **By touching the relevant cooking zone symbol for 3 seconds.**
Touch the symbol of the cooking zone that you want to turn off for about 3 seconds.

High Power (Booster) Function

For rapid heating, you can use booster function. However, this function is not recommended for cooking a long time. Booster function may not be available in all cooking zones.

Selecting Booster directly:

1. Touch "⏻" key to turn on the hob.
2. Select the desired cooking zone by touching the Cooking Zone Selection keys.

3. Touch the "⏻" key.

Selected cooking zone will operate at the maximum power and 3 lights will flash on the cooking zone display respectively. When booster time ends, cooking zone turns off.

Selecting Booster when cooking zone is active:

1. Touch "⏻" after cooking zone has operated at least 20 seconds on a certain level.



Cooking zone should complete operating for at least 20 seconds on the selected level.

2. Selected cooking zone will operate at the maximum power and 3 lights will flash on the cooking zone display respectively. Once the Booster period is over, the cooking zone switches to the set temperature level and only the selected temperature value is displayed.

Turning off Booster function prematurely:

Touch "⏻" to turn off booster any time you want.

Quick heating

Quick heating is a function which facilitates cooking. All cooking zones are equipped with Quick heating function. This function can be operated by setting temperature level beforehand.



Quick heating function can be set within 20 seconds after cooking zone is switched on.

Selecting Quick heating function:

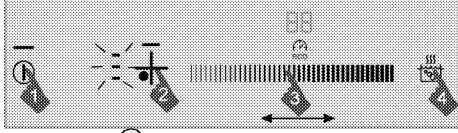

1. Touch "1" key to turn on the hob.
 2. Select the desired cooking zone by touching the Cooking Zone Selection keys.
 3. Adjust the desired temperature level by touching the adjustment area or by sliding your finger across the area.
 4. Touch the "☀️⚡️" key.
- The cooking zone you have selected will operate at maximum power for a certain period of time. 3 lights and the set temperature value will appear on the cooking zone display respectively.
5. Once the Quick heating period is over, the cooking zone switches to the set temperature level and only the selected temperature value is displayed.

Table: Quick Heating Operation Times

Temperature level	Operation time limit - second
0	0
1	10
2	10
3	20
4	30
5	40
6	47
7	56
8	65
9	75
10	85
11	85
12	25
13	25
14	35
15	35
16	45
17	45
18	10

Turning off Quick heating function:

Touch "☀️⚡️" key to turn off the Quick heating function whenever you want.



If the Quick heating function has been activated by selecting the temperature level, the cooking zone will continue operating at the set temperature level when "☀️⚡️" is pressed.

Turning on multi-segmented cooking zones

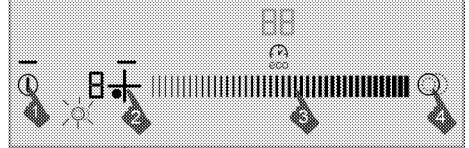

1. Touch "1" key to turn on the hob.
2. Select the multi-segmented cooking zone by touching the Cooking Zone Selection keys.
3. Adjust the desired temperature level by touching the adjustment area or by sliding your finger across the area.
4. Touch "☀️•" key on the control panel to turn on the multi-segment of the cooking zone.

"☀️•" symbol appears on the display of the relevant cooking zone.



The multi-segment will be activated only if a temperature level between "1" and "19" is set for the main segment of the cooking zone.

Turning off multi-segment cooking zones

1. Touch "☀️•" key on the control panel to turn off the multi-segment of the cooking zone.
- "☀️•" symbol on the display of relevant cooking zone disappears and multi-segment of the cooking zone turns off. The main segment of the relevant cooking zone goes on operating at the set temperature.

Cleaning lock

The cleaning lock prevents operation of all keys on the control panel for 20 seconds to allow the user to make a short cleaning while the hob is in use.

Activating the cleaning lock

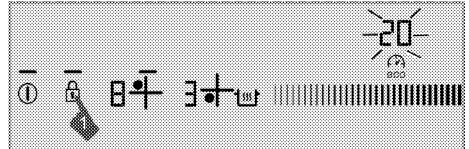

1. When the hob is in On mode, press and hold "🔒" key until a **single signal sound** is heard.

Cleaning lock light will illuminate and the clock display of the hob will start to count down from 20. None of

the keys on the control panel will be functional throughout this period except "⏸" key.

Deactivating the cleaning lock

You do not have to press any key to deactivate the cleaning lock. The hob will give an audio signal after 20 seconds, keylock light will turn off and the cleaning lock is automatically deactivated.

 If you want to deactivate the cleaning lock earlier, press and hold the "🔒" key until **two intermittent signal sounds** are heard.

Child Lock

When the hob is in Standby mode, you can protect the hob with child lock to prevent children from turning on the cooking zones. Child Lock can be activated or deactivated in Standby mode only.

Activating the Child Lock

1. When the hob is in Standby model, press and hold "🔒" key until **two signal sounds** are heard.

The Child Lock will be activated and the light of the "🔒" key will turn off.

 If any key is pressed when the Child Lock is active, the light of the "🔒" key flashes.

Deactivating the Child Lock

1. When the Child Lock is activated, press and hold "🔒" key until a **single signal sound** is heard.

» Child Lock will be deactivated and the light of the "🔒" key will turn off.

Keylock

You can activate the keylock to avoid changing the functions by mistake when the hob is operating.

Activating the keylock

1. Touch and hold the "🔒" key for a long time to lock the control panel.

Only one signal sound will be heard first. In this case, your hob is switched to **Cleaning Lock**. Then, **keep on touching without lifting your finger until you hear two successive signal sounds**.

The light of the "🔒" key will flash and all cooking zones will be locked.

 You can activate the keylock in operation mode only. When keylock is activated, only the "⏸" key will be functional. When you touch any

other key, the light of the "🔒" key will flash to indicate that the keylock is active. If you turn the hob off when the keys are locked, the keylock must be deactivated to turn the hob on again.

Deactivating the keylock

1. Keep "🔒" key pressed for 2 seconds.

The operation is confirmed with an audible signal. The

light of the "🔒" key turns off and the control panel is unlocked.

Economic timer function

 The timer can only be set between 0-99 minutes.

When the timer is set you will not need to continually monitor the pans on the hob. Cooking zone will be turned off automatically at the end of the time you have selected.

While cooking with this function, your hob will adjust the power automatically towards the end of cooking and allow power savings by using the residual heat.

Activating the timer

1. Touch "⏸" key to turn on the hob.
2. Select the desired cooking zone by touching the Cooking Zone Selection keys.
3. Adjust the desired temperature level by touching the adjustment area or by sliding your finger across the area.
4. Touch "🕒" key to activate the timer. "00" appears on the timer display and "🕒" symbol starts flashing on the cooking zone display.
5. Adjust the desired time period by touching the adjustment area or by sliding your finger across the area.

After flashing for a certain period of time, the "🕒" symbol lights up permanently. Lighting up of "🕒" symbol continuously indicates that the function is activated.

 The timer can only be set for the cooking zones already in use.

 Repeat the above procedures for the other cooking zones for which you wish to set the timer.

 Timer cannot be adjusted unless the cooking zone and the temperature value for the cooking zone are selected.

 When the timer is activated, only the set time for the selected cooking zone will appear on the timer display.

Deactivating the timer

Once the set time is over, the hob will automatically turn off and give an audible warning.

Press any key to silence the audio warning.

Turning off the timers earlier

If you turn off the timer earlier, the hob will carry on operating at the set temperature until it is turned off.



You can turn the timer off in two different ways:

1-Turning off the timer by dropping its value down to "00":

1. Select the cooking zone you want to turn off.
2. Touch "" key to select the timer of the relevant cooking zone.
3. Decrease the value until "00" appears on the timer display by touching the adjustment area or by sliding your finger across the area.

 symbol flashes on the cooking zone display for a certain time period and then it turns off **permanently** and the timer is canceled.

2-Turning off the timer by pressing timer key for 3 seconds:

1. Select the cooking zone you want to turn off.
2. Touch "" key to select the timer of the relevant cooking zone.
3. Touch "" key for about 3 seconds.



 symbol flashes on the cooking zone display for a certain time period and then it turns off **permanently** and the timer is canceled.

Keep warm function (if any)

You can use this function to keep your meal warm after the cooking process is completed. The keep warm function may be used in two different ways: with and without setting the timer.

Activating the keep warm function without setting the timer

1. Select the cooking zone that has been set to a certain temperature and you want to use for keeping warm.
2. Touch "" key to activate the keep warm function for the relevant cooking zone.

 The cooking zone will go on operating at low temperature. "" and "u" symbols appear on the cooking zone display.

Activating the keep warm function by setting the timer

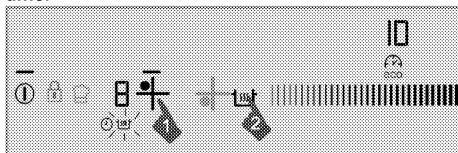

1. Select the desired cooking zone for which the temperature and timer has been set, and you are planning to run the keep warm function.
2. Touch "" key to activate the keep warm function for the relevant cooking zone.



 symbol appears on the cooking zone display.

The cooking zone will keep on operating at the set temperature throughout the set time period. When the time is over, it switches to keep warm function and starts operating at low temperature. "u" symbol appears on the cooking zone display.

Turning off the keep warm function

1. If the timer is activated, select the cooking zone for which the keep warm function is activated. Touch "" key to turn off the keep warm function. The cooking zone will continue operating with the previous time and temperature setting.
2. If the timer is deactivated, select the cooking zone for which the keep warm function is activated. Set the desired temperature by touching the adjustment area or by sliding your finger across it in order to deactivate the keep warm function.

The cooking zone will go on operating at the new temperature you have set.

 You can cancel the keep warm function by touching the "" key and turning off the hob entirely.

Stop function

Using this function, you may stop all functions operating on the hob (**except timer**) for a certain period of time.

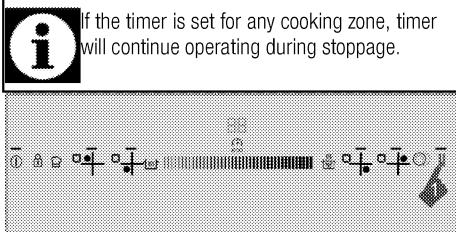

1. Touch the "||" key when your hob is operating. All active cooking zones will stop.
2. Touch "||" key again to restart all stopped cooking zones with previous settings.

Memory function

Your hob can save a certain cooking temperature and time in the memory. Thanks to this function, you can store the cooking temperature and time of a dish you enjoyed.

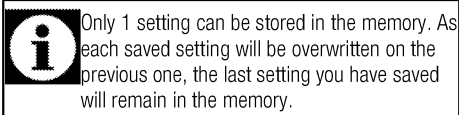

1. Touch "O" key to turn on the hob.
2. Select the desired cooking zone by touching the Cooking Zone Selection keys.
3. Adjust the desired temperature by touching the adjustment area or by sliding your finger across the area.
4. Adjust the desired time as well.
5. After adjusting the temperature and time, touch the "☺" symbol until you hear **two warning sounds**.

The "☺" symbol will light up and the set temperature and time are saved into memory.

Using the settings in the memory

1. Select the desired cooking zone by touching the Cooking Zone Selection keys.
2. When the temperature value is "0", touch "☺" key until you hear a **single warning sound**.

The selected cooking zone will be set to the temperature and time in the memory, and commence operating with these settings.

Operation time constraints

The hob control is equipped with an operation time limit. When one or more cooking zones are left on, the cooking zone will automatically be deactivated after a certain period of time (see Table-1). If there is a timer assigned to the cooking zone, the timer display will also turn off later.

Operation time limit depends on the selected temperature level. Maximum operation time is applied at this temperature level.

The cooking zone may be restarted by the user after it is turned off automatically as described above.

Table-1: Operation time constraints

Temperature level	Operation time limit - hour
0	0
1	6
2	6
3	5
4	5
5	4
6	4
7	3
8	3
9	2,5
10	2,5
11	2
12	2
13	1,5
14	1,5
15	1
16	1
17	0,5
18	0,5
19	0,5
Booster	10 minutes

Overheating protection

Your hob is equipped with some sensors ensuring protection against overheating. Following may be observed in case of overheating:

- Active cooking zone may be turned off.
- Selected level may drop. However, this condition cannot be seen on the indicator.

Error messages

Table-2:Error codes and error sources

Cause of error	Indicator	Display
Two or more keys are pressed	"E" symbol flashes	Cooking zone display
Hob overheated	"H" symbol flashes	Cooking zone display
PTC short circuit	"F0" symbol lights up	Timer display
PTC open circuit	"F1" symbol lights up	Timer display
Touch-key sensitivity error	"F2" symbol lights up	Timer display
Communication error in touch control	"F3" symbol lights up	Timer display
Induction hardware error	"EX" symbol flashes	Cooking zone display



For further information about error messages that may appear on the touch control panel, see Table-2.



If the surface of the touch control panel is exposed to intense vapor, entire control system may become deactivated and give error signal.



Keep the surface of the touch control panel clean. Erroneous operation may be observed.

6 Maintenance and care

General information

Service life of the product will extend and the possibility of problems will decrease if the product is cleaned at regular intervals.



DANGER:

Disconnect the product from mains supply before starting maintenance and cleaning works.
There is the risk of electric shock!



DANGER:

Allow the product to cool down before you clean it.
Hot surfaces may cause burns!

- Clean the product thoroughly after each use. In this way it will be possible to remove cooking residues more easily, thus avoiding these from burning the next time the appliance is used.
- No special cleaning agents are required for cleaning the product. Use warm water with washing liquid, a soft cloth or sponge to clean the product and wipe it with a dry cloth.
- Always ensure any excess liquid is thoroughly wiped off after cleaning and any spillage is immediately wiped dry.
- Do not use cleaning agents that contain acid or chloride to clean the stainless or inox surfaces and the handle. Use a soft cloth with a liquid detergent (not abrasive) to wipe those parts clean, paying attention to sweep in one direction.



The surface might get damaged by some detergents or cleaning materials.
Do not use aggressive detergents, cleaning powders/creams or any sharp objects during cleaning.
Do not use harsh abrasive cleaners or sharp metal scrapers to clean the oven door glass since they can scratch the surface, which may result in shattering of the glass.



Do not use steam cleaners to clean the appliance as this may cause an electric shock.

Cleaning the hob

Glass ceramic surfaces

Wipe the glass ceramic surface using a piece of cloth dampened with cold water in a manner as not to leave any cleaning agent on it. Dry with a soft and dry cloth. Residues may cause damage on the glass ceramic surface when using the hob for the next time.

Dried residues on the glass ceramic surface should under no circumstances be scraped with hook blades, steel wool or similar tools.

Remove calcium stains (yellow stains) by a small amount of lime remover such as vinegar or lemon juice. You can also use suitable commercially available products.

If the surface is heavily soiled, apply the cleaning agent on a sponge and wait until it is absorbed well. Then, clean the surface of the hob with a damp cloth.



Sugar-based foods such as thick cream and syrup must be cleaned promptly without waiting the surface to cool down. Otherwise, glass ceramic surface may be damaged permanently.

Slight color fading may occur on coatings or other surfaces in time. This will not affect operation of the product.

Color fading and stains on the glass ceramic surface is a normal condition, and not a defect.

7 Troubleshooting

Water drops occur during cooking.

- The vapour that arises during cooking can condense and form water droplets when it hits cold surfaces of the product. >>> *This is not a fault.*

Product emits metal noises while heating and cooling.

- When the metal parts are heated, they may expand and cause noise. >>> *This is not a fault.*

Product does not operate.

- The mains fuse is defective or has tripped. >>> *Check fuses in the fuse box. If necessary, replace or reset them.*
- Product is not plugged into the (grounded) socket. >>> *Check the plug connection.*
- If the display does not light up when you switch the hob on again. >>> *Disconnect the appliance at the circuit breaker. Wait 20 seconds and then reconnect it.*

Cooling fan continues operating although the hob is turned off.

- This is not a fault. Cooling fan will continue operating until the electronics in the hob cools down to a suitable temperature.



Consult the Authorised Service Agent or technician with licence or the dealer where you have purchased the product if you can not remedy the trouble although you have implemented the instructions in this section. Never attempt to repair a defective product yourself.

